

PRODUCT SPECIFICATION

93037

Bista

(Cycle stand/charging station)

Introducing BISTA, a bike rack for parking and charging bikes. Available in sustainable woods including Accoya, oak and chestnut, this bike rack will fit beautifully into any outdoor environment, from parks to office and school bike parking. With an IP55 rating, BISTA offers protection against dust and water, ensuring reliability no matter the weather.

The BISTA has a voltage of 230 volts and offers the choice of a single or double socket, ideal for charging multiple bicycles simultaneously. The BISTA can optionally be provided with a bicycle logo, which contributes to its recognisability. The BISTA creates a practical, stylish and sustainable solution for storing and charging electric bicycles.



PRODUCT FEATURES

- IP Class IP55
- Voltage 230V
- Connection: None, single or double socket
- Wood type: Accoya, oak or chestnut
- Dimensions 100x100mm or 150x150mm
- Quality Mark as FSC or PEFC
- Accessories: Postholder

RELATED PRODUCTS - 71030 Canterbury - Cycle Stand



PRODUCT SPECIFICATION

POST HOLDERS

To mount the products on, for example, a deck, concrete foundation, tile or roof terrace, an extensive range of post holders and foundation elements are available to choose from. Above ground mounting has a positive effect on the lifespan of timber products.



PH05

Post holder 150 with flange
Models: EYE 150, EYE SOLAR, PERI 150,
TORRE 150, TORRE SOLAR & FARO
Material: Stainless steel 316
Weight: 4 kg

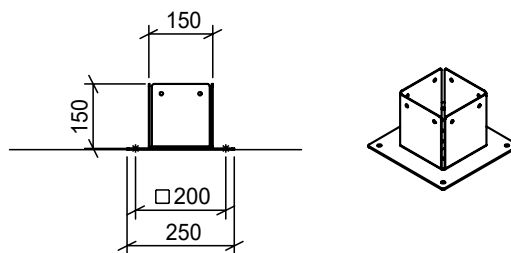

PH06

Post holder (per 3)
Models: BOSCO, BOSCO SOLAR, PIATTO, BASSO & SOTTO
Material: Stainless steel 316
Weight: 2 kg

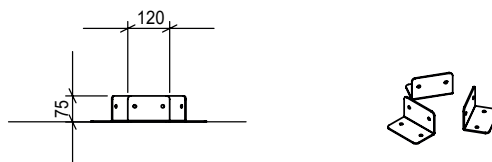

PH02

Post holder 100 with flange
Models: EYE 100, PERI 100 & TORRE 100
Material: Stainless steel 316
Weight: 3 kg

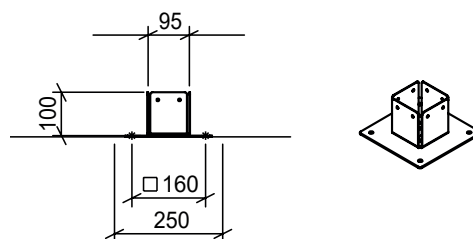

PH03

Post holder 100 with spike
Models: EYE 100, PERI 100 & TORRE 100
Material: Stainless steel 316
Weight: 2 kg

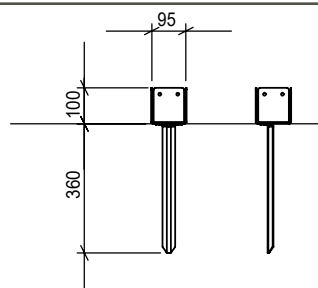

PRODUCT SPECIFICATION

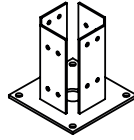
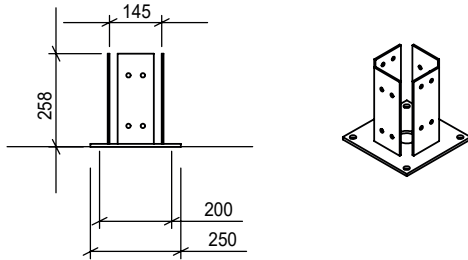

PH07

Post holder lamp post

Models: STRATO, STELLE, ANGELO & PILA

Material: Galvanised steel

Weight: 7 kg

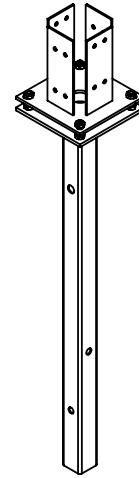
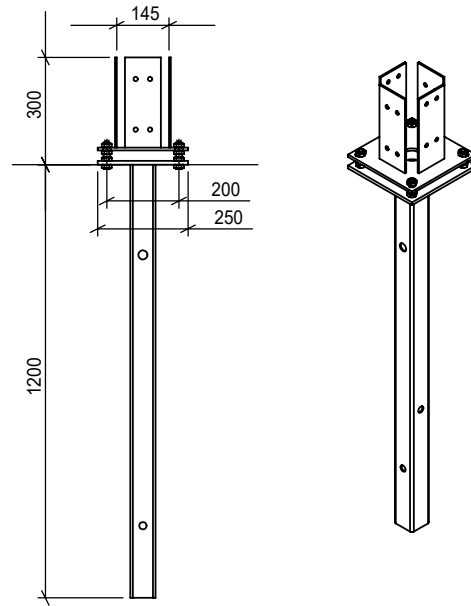

PH08

Post holder

Models: STRATO, STELLE, ANGELO & PILA

Material: Galvanised steel

Weight: 20 kg

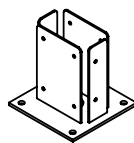
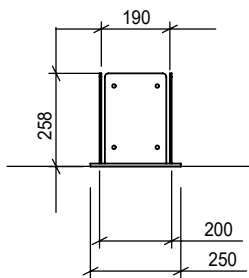

PH09

Post holder RIPARO

Models: RIPARO

Material: Stainless steel 316

Weight: 7 kg

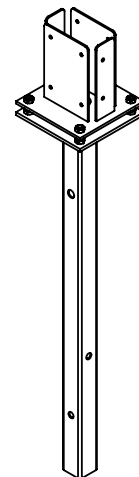
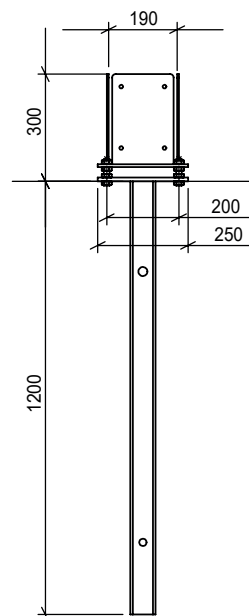

PH10

Post holder RIPARO

Models: RIPARO

Material: Stainless steel 316

Weight: 20 kg